



HP50HA ABG Heat Pump

Troubleshooting Guide Residential



Safety Precautions



High Voltage Electrocution Hazard

Hazardous voltage can shock, burn, cause serious injury and or death. To reduce the risk of electrocution and or electric shock hazards:

- Only qualified technicians should remove the dead front
- Replace damaged wiring immediately
- Ensure panel is properly grounded and bonded

Table of Contents

How the Heat Pump Works & Specifications	Pg. 4-5
Replacement Parts & 4.8k ohm Chart	Pg. 6-7
Display Functions and Descriptions	Pg. 8
How To:	Pg. 9-15
Toggle ON/OFF and Mode & Lock/Unlock Heat Pump	10-11
Set Pool Temperature & Set Clock	12-14
Set Timer ON/OFF & Cancel Existing Timers	15-17
Check a Capacitor (multi-meter)	18
Troubleshooting:	Pg. 19-48
1. Error Code: P01,P02,P04, or P05	20-21
2. Error Code: P07	22-23
3. Error Code: E01	24-27
4. Error Code: E02	28-35
5. Error Code: E03	36-39
6. Error Code: E06	40-41
7. Error Code: E07/E19/E29	42-45
8. Error Code: E08	46-47
Reading Serial Numbers	Pg. 48

ABG Heat Pump: How It Works

- The Hayward HP50HA Heat Pump provides the perfect pool water temperature to enhance the enjoyment of your pool throughout the swimming season. This is achieved through heating and cooling modes that work in concert to achieve an ideal swimming temperature that is user defined.
- With its 45,000 BTU heating capacity, this heat pump is designed for small above ground pools up to 13,000 gallons.
- It features a durable Titanium Heat Exchanger, has an electronic thermostat control, and offers quiet operation.



ABG Heat Pump: Specifications

HP50A/HP50HA - Specifications	
Heating Capacity	14.7kW
	50,000 BTU/h
Refrigerant Type	R-410A
Heating Power Input	2.68kW
Running Current	12A
Power Supply	208-230VAC/60Hz
Compressor Quantity	1
Compressor	Rotary
Fan Quantity	1
Fan Power Input	120W
Fan Rotate Speed	850RPM
Fan Orientation	Horizontal
Noise (at 1 meter)	54 dB(A)
Water Connection	1.5 inch
Water Flow Volume US	20GPM
Water Pressure Drop (max)	1.5 psi
Unit Net Dimensions (L/W/H)	41.5"x16.5"x25.6"
Unit Shipping Dimensions (L/W/H)	43.7"x18.5"x26.4"
Shipping Weight	128lbs
<i>Heating: Ambient temp (DB/WB): 75°F (24°C) / 66°F (19°C)</i>	
<i>Water temp (in/out): 79°F (26°C) / 82°F (28°C)</i>	

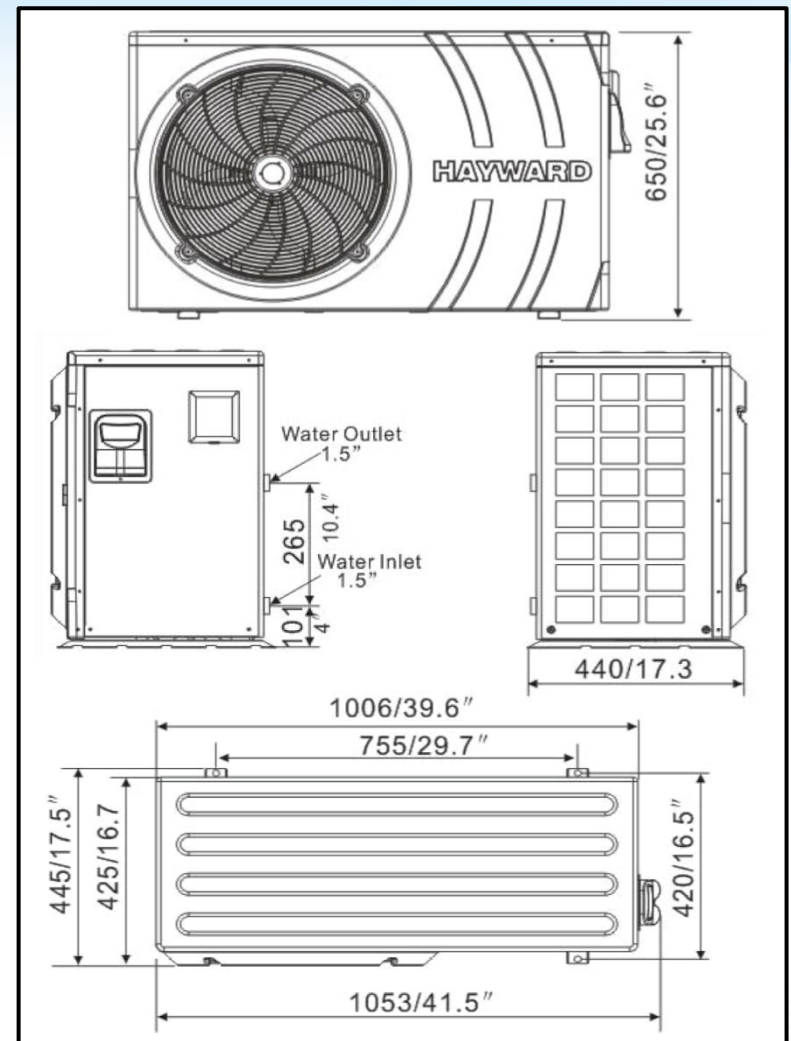

ABG Heat Pump: Replacement Parts

Part Numbers	Description:	Part Numbers	Description:
HPX2000-3242	Temperature Sensor	HPX32012-220045	Top Panel Cover
HPXMCB50	Main Control PCB	HPX2001-1418	4 Way Valve
HPX2001-3605	High Pressure Switch	HPX32012-120031	Evaporator
HPX20000-3603	Low Pressure Switch	HPX32012-120014	Titanium Tube Heat Exchanger
HPX20000-360005	Flow Switch	HPX2000-2111	Water Proof Cover for Display
HPX95005-310188	Display (user interface)	HPX20000-110041	Compressor
HPX20000-220188	Fan Guard	HPX20000-360006	Contactator
HPX32012-220044	Front Panel Cover	HPX2001-3907	Wiring Terminal
HPX3500-2701	Fan Blade	HPX2000-3505	Compressor Capacitor
HPX20000-330124	Fan Motor	HPX20000-350012	Fan Capacitor
HPX20000-140153	Needle Valve		

4.8k ohm Temperature/Resistance Chart

Use the following chart to determine the reported temperature of a sensor based on resistance (with sensor disconnected):

4.8k ohm Sensor Temperature / Resistance Chart					
Temp °F	Temp °C	Sensor resistance (k ohm)	Temp °F	Temp °C	Sensor resistance (k ohm)
180.0	82.2	0.549	80.0	27.2	4.37
175.0	79.4	0.601	75.0	24.4	4.935
170.0	76.7	0.659	70.0	21.7	5.583
165.0	73.9	0.722	65.0	18.9	6.328
160.0	71.2	0.793	60.0	16.2	7.187
155.0	68.4	0.872	55.0	13.4	8.18
150.0	65.7	0.961	50.0	10.7	9.334
145.0	62.9	1.06	45.0	7.9	10.671
140.0	60.2	1.17	40.0	5.2	12.23
135.0	57.4	1.294	35.0	2.4	14.044
130.0	54.7	1.434	30.0	-0.3	16.167
125.0	51.9	1.591	25.0	-3.1	18.655
120.0	49.2	1.768	20.0	-5.8	21.581
115.0	46.4	1.968	15.0	-8.6	25.036
110.0	43.7	2.194	10.0	-11.3	29.11
105.0	40.9	2.451	5.0	-14.1	33.95
100.0	38.2	2.741	0.0	-16.8	39.683
95.0	35.4	3.072			
90.0	32.7	3.448			
85.0	29.9	3.879			

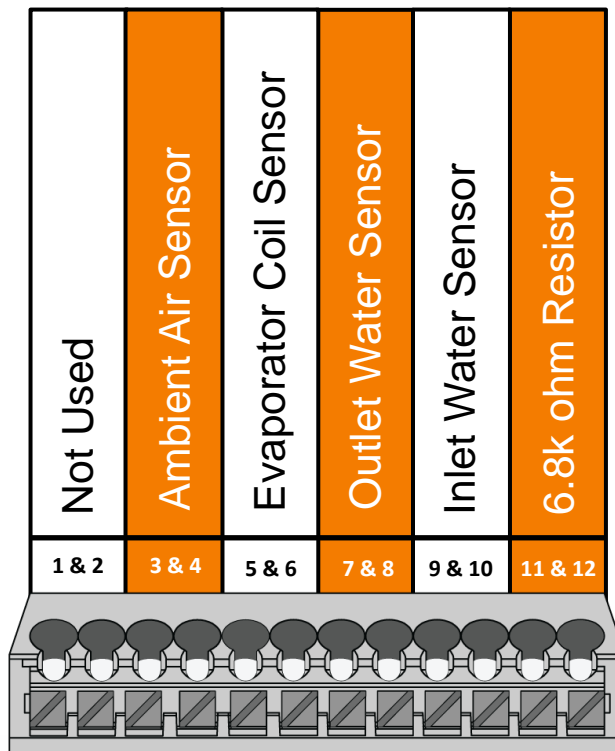

Display Functions & Descriptions

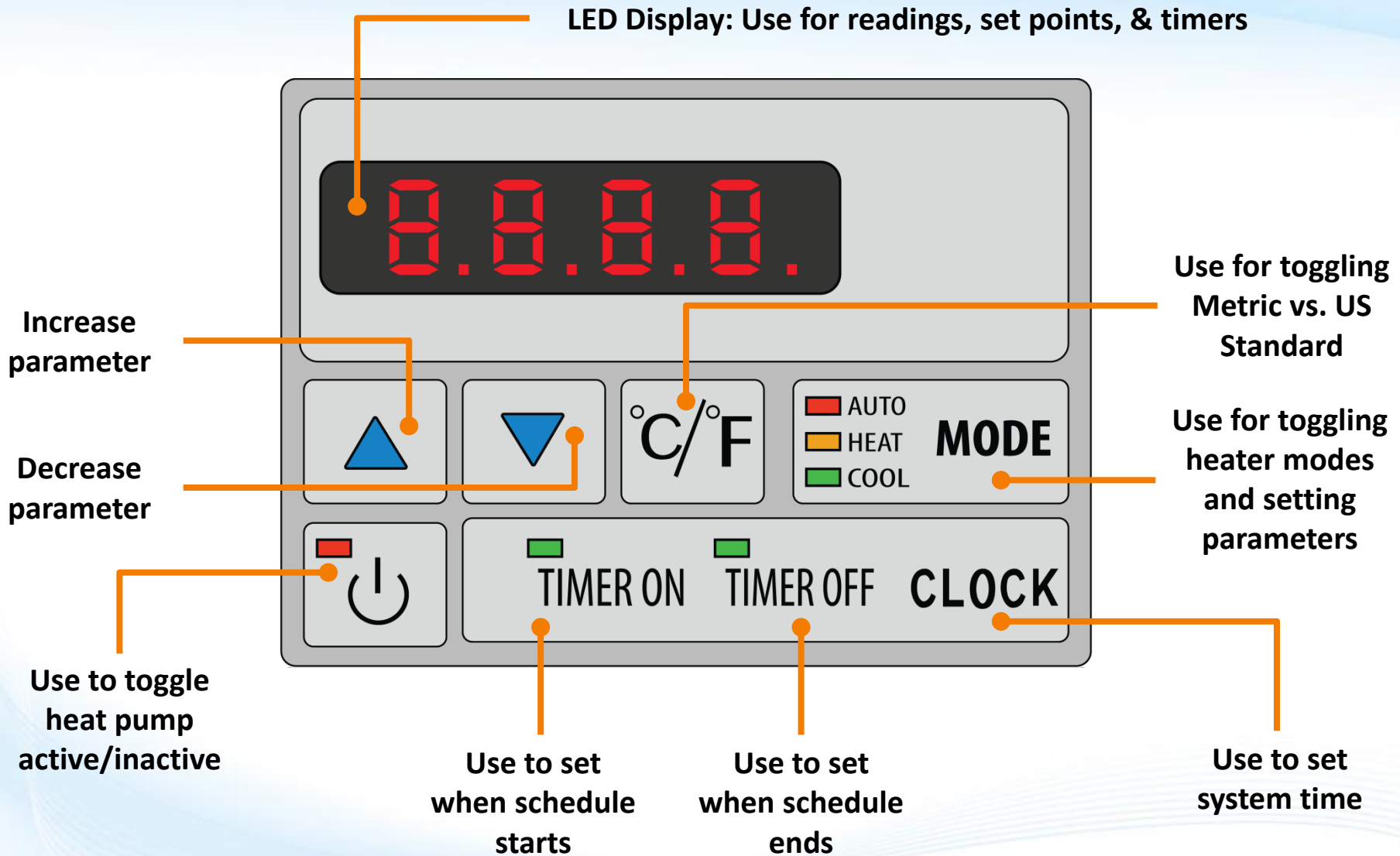



HP50HA ABG Heat Pump

How To:



How To: Toggling ON/OFF & Mode

Follow these steps instructions to activate/deactivate the heat pump OR to toggle between Auto, Heat, and Cool modes.

Heat Pump Active



Press
Power
Button

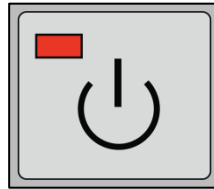

To activate the heat pump, press & release the power button (DO NOT HOLD). The power LED should appear in Red when the heat pump is activated.

Heat Pump Inactive



Press
Power
Button

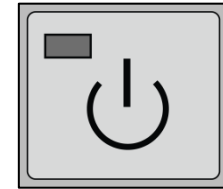

To deactivate the heat pump, press & release the power button (DO NOT HOLD). The power LED should go out when the heat pump is deactivated.



Press the 'MODE' button to toggle between: Auto, Heat, and Cool. While toggling the "MODE" button the temperature should appear on the display.

How To: Lock/Unlock Heat Pump

Follow these steps instructions to Lock or Unlock the Heat Pump.

Lock Heat Pump



**Press & Hold
Power for
5 seconds**

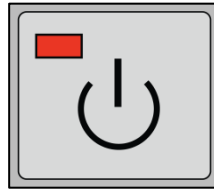

To Lock the heat pump, **PRESS & HOLD** the power button for 5 seconds. Once complete, a locked icon should appear on the display.

Heat Pump Inactive



**Press & Hold
Power for
5 seconds**

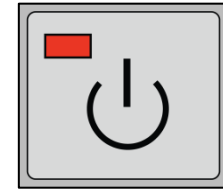

To Unlock the heat pump, **PRESS & HOLD** the power button for 5 seconds. Once complete, the locked icon should disappear from the display.

How To: Set Pool Temperature

Follow these steps to set the pool temperature.

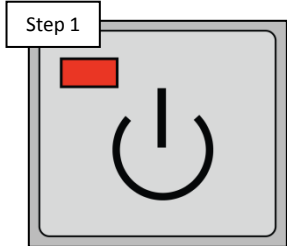

Verify the heater's power LED is illuminated, and put the heater in the desired mode.

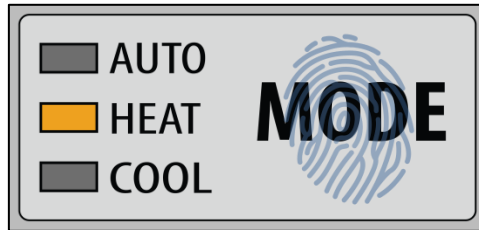

Using the up and down arrows adjust the heater to the desired temperature.

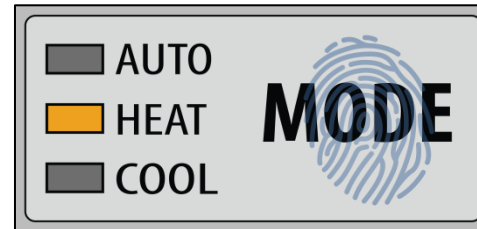
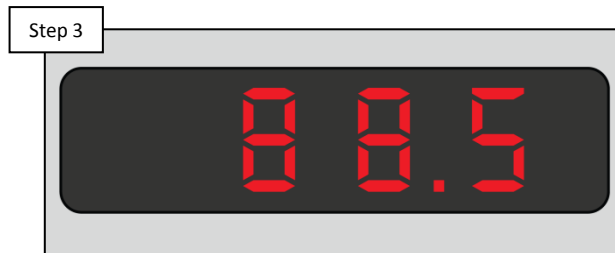

Once desired temperature has been set, press the "MODE" button to save set point.

Note: Step 3, IF you wish to cancel the set point change, press the Power button instead of "MODE".

How To: Set Clock

Follow these steps to adjust the Clock Settings. Note: blocked off areas of the display represent flashing numbers.

Step 1

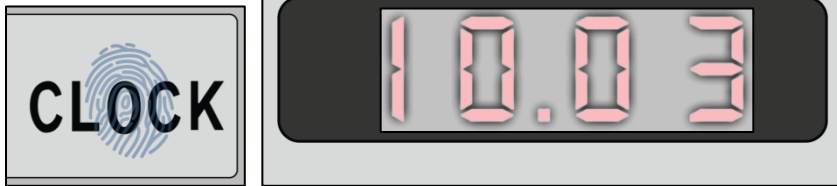

Press the "CLOCK" button to show the current time; it will appear in a flashing state.

Step 2

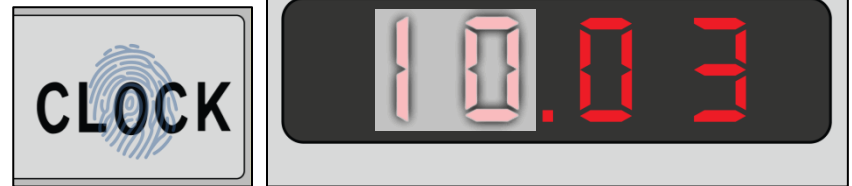

Press "CLOCK" a second time, the hours portion of the clock will be flashing at this point.

Step 3

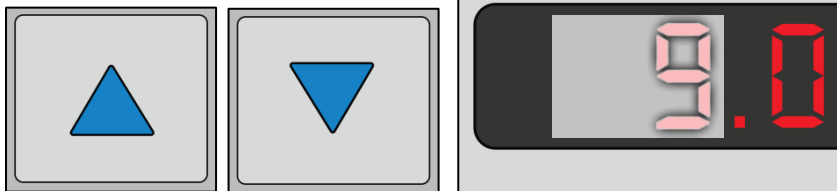

Use the up or down arrow to adjust the hours.

Step 4



Press the "CLOCK" button, this will cause the minutes to flash.

How To: Set Clock (cont.)

Note: blocked off areas of the display represent flashing numbers.

Step 5

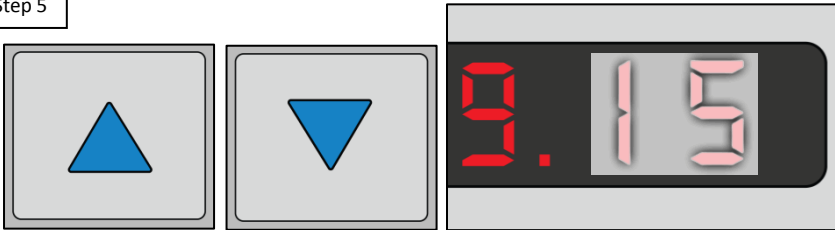

Use the up or down arrow to adjust the hours.

Step 6



Press "CLOCK" a final time to save and exit.

Note: Step 6, IF you wish to cancel all changes, press the Power button instead of "CLOCK".

How To: Set Timer ON/OFF

Follow these steps to adjust the ON/OFF timer. Note: blocked off areas of the display represent flashing numbers.

Step 1

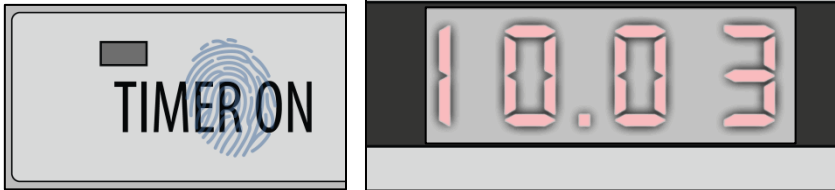

Press the "TIMER ON" button to show the start time; it will appear in a flashing state.

Step 2

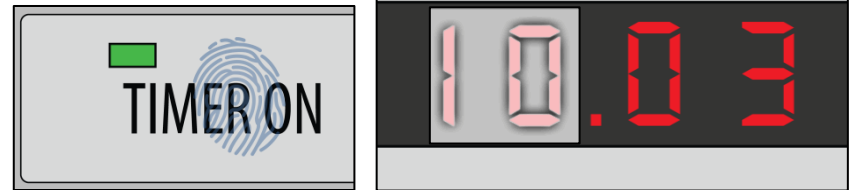

Press "TIMER ON" a second time, the hours portion of the start time will be flashing at this point.

Step 3

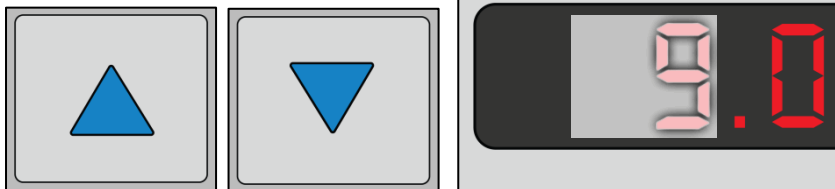

Use the up or down arrow to adjust the hours.

Step 4

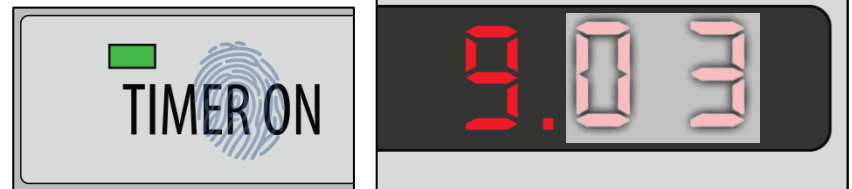

Press the "TIMER ON" button, this will cause minutes to flash.

How To: Set Timer ON/OFF (cont.)

Note: blocked off areas of the display represent flashing numbers.

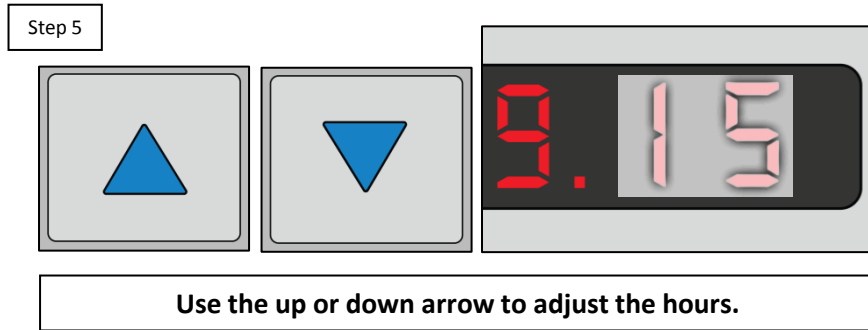

***NOTE: YOU MUST ALSO SET OFF TIME:** To set the OFF time, repeat steps 1-6, ONLY this time press the "TIMER OFF" button.

Note: Step 6, IF you wish to cancel all changes, press the Power button instead of "TIMER ON".

How To: Cancel Existing Timers

Follow these steps to cancel the ON/OFF timer. Note: blocked off areas of the display represent flashing numbers.

Step 1

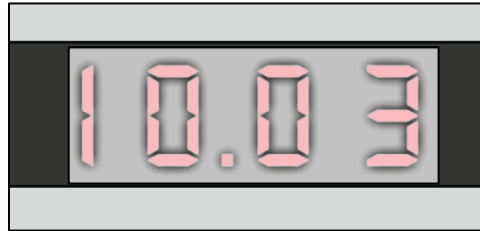

Press the "TIMER ON" button to show the start time; it will appear in a flashing state.

Step 2

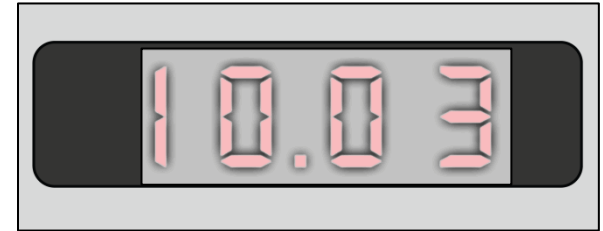
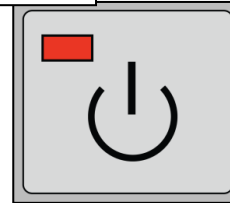

Press & release the power button to cancel this ON timer (DO NOT HOLD DOWN).

Step 3

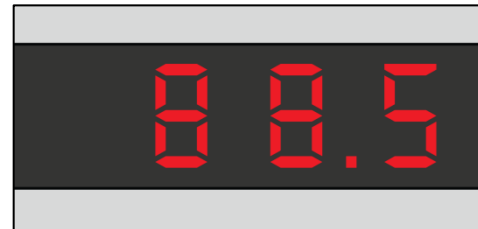
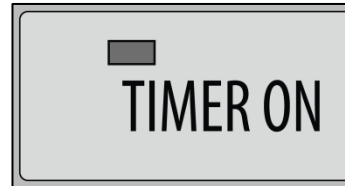

NOTE: At this point the Timer ON LED should have gone out & the display should return to the temperature reading. *

***NOTE YOU MUST ALSO CANCEL OFF TIME:** repeat steps 1-3, ONLY this time press the "TIMER OFF" button.

How To: Check A Capacitor (multi-meter)

Follow these steps when attempting to test a capacitor (using an multi-meter).

- Step 1** First, document how wires are attached then remove all wires from capacitor.
- Step 2** Set multi-meter to ohms (60K range OR highest possible option if less than 60K).
- Step 3** Touch one probe to one set of terminals, and while looking at the meter touch the other set.
- Step 4** For a split second, the meter should show a reading and then return to OL or blank.
- Step 5a** If the meter's display shows 0.0, or constant continuity, the capacitor should be replaced.
- Step 5b** If the meter's display never shows a reading, then the capacitor needs to be replaced.

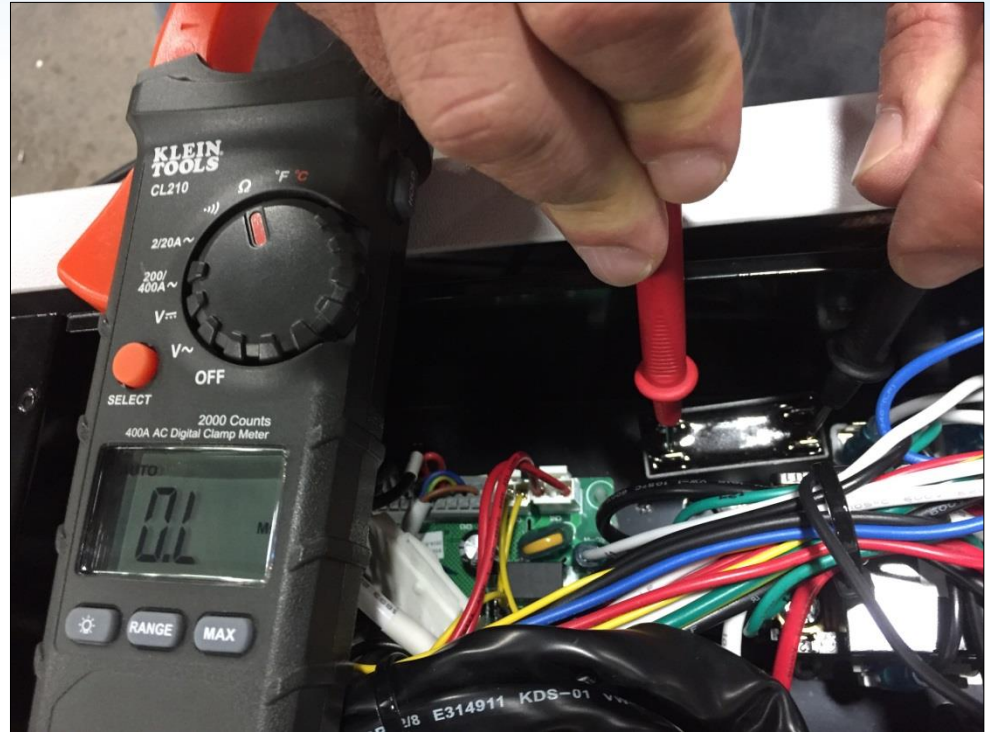

Visual Clues Warranting a Capacitor Replacement

If capacitor is swollen.

If any of the posts/terminals are loose.

More than one instance of a burned wire connecting to a capacitor



HP50HA ABG Heat Pump

Troubleshooting



1. Error Code: P01, P02, P04 or P05

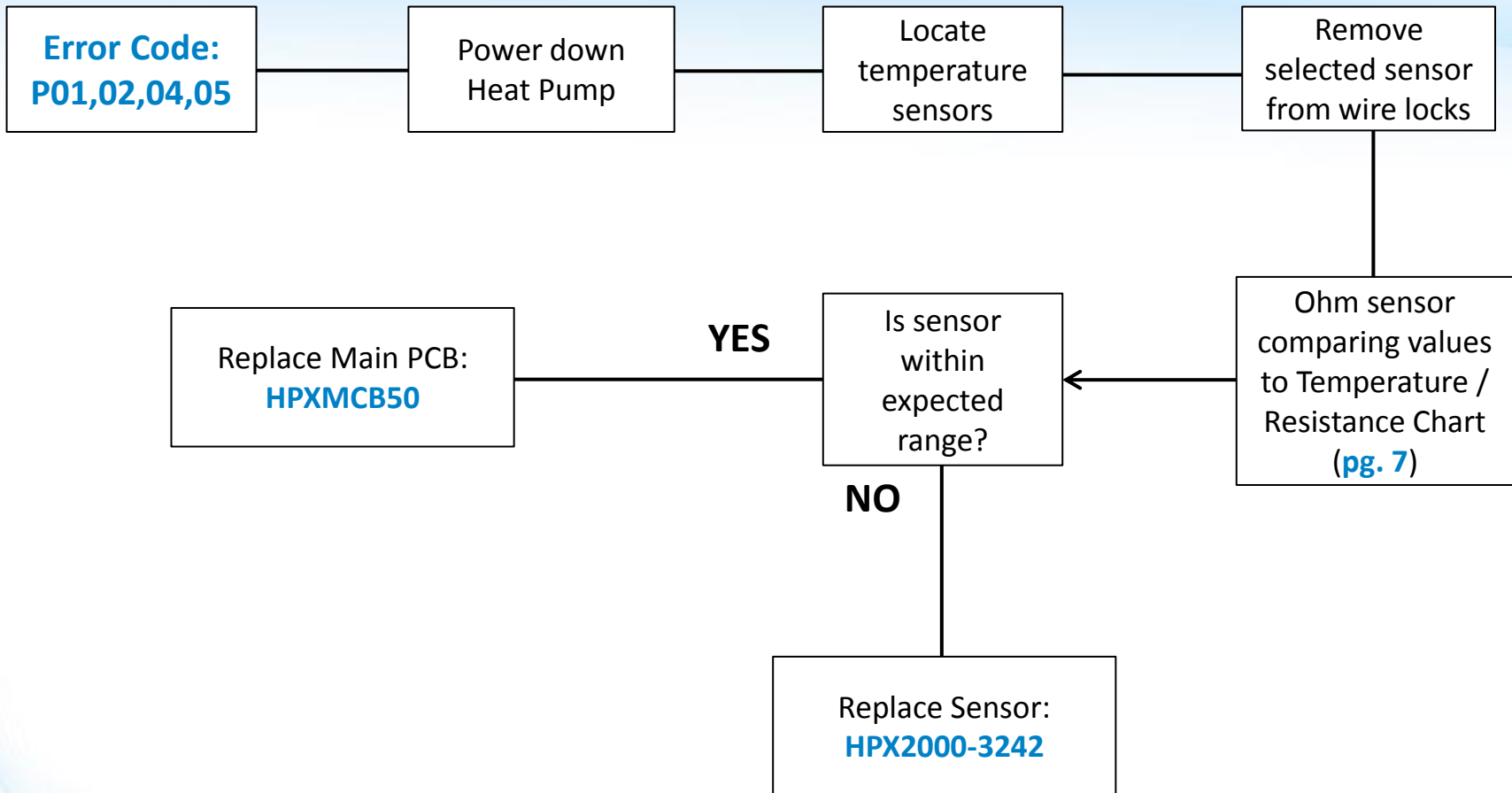

1. Error Code: P01, P02, P04 or P05

The P01, P02, P04, and P05 errors are all related to temperature readings provided by the four temperature sensors; failures may include (sensor failure, broken wire to sensor, or a control board problem).

Power Down & Locate Sensors

Step 1A

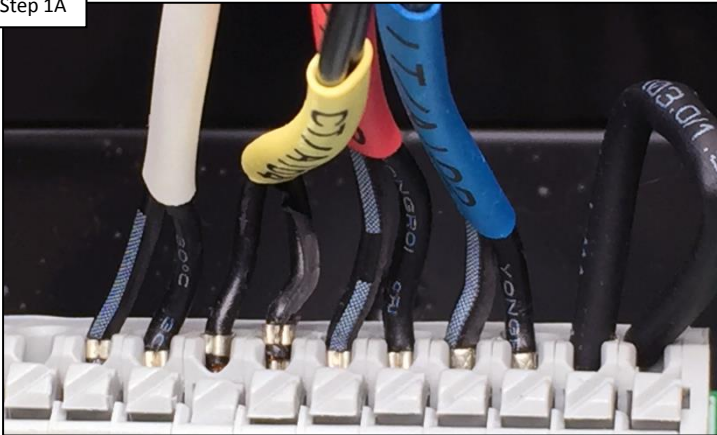

Power down the heat pump, and locate the sensors. Using a comm screwdriver, depress wire locks to release selected sensor, and remove them each from their terminals. Proceed to step 1B, to ohm sensor.

Ohm Temp Sensors

Step 1B

Position (left>right)	Purpose	ERROR
1 & 2	Not Used	N/A
3 & 4	Ambient Air Sensor	P04
5 & 6	Evaporator Coil Sensor	P05
7 & 8	Outlet Water Sensor	P02
9 & 10	Inlet Water Sensor	P01
11 & 12	6.8k ohm Resistor	P07

Ohm out each sensor comparing values to temperature / resistance chart (pg. 7). IF sensor(s) are out of expected temp range, replace sensor(s) (HPX2000-3242). IF correct, replace main board (HPXMCB50)

2. Error Code: P07

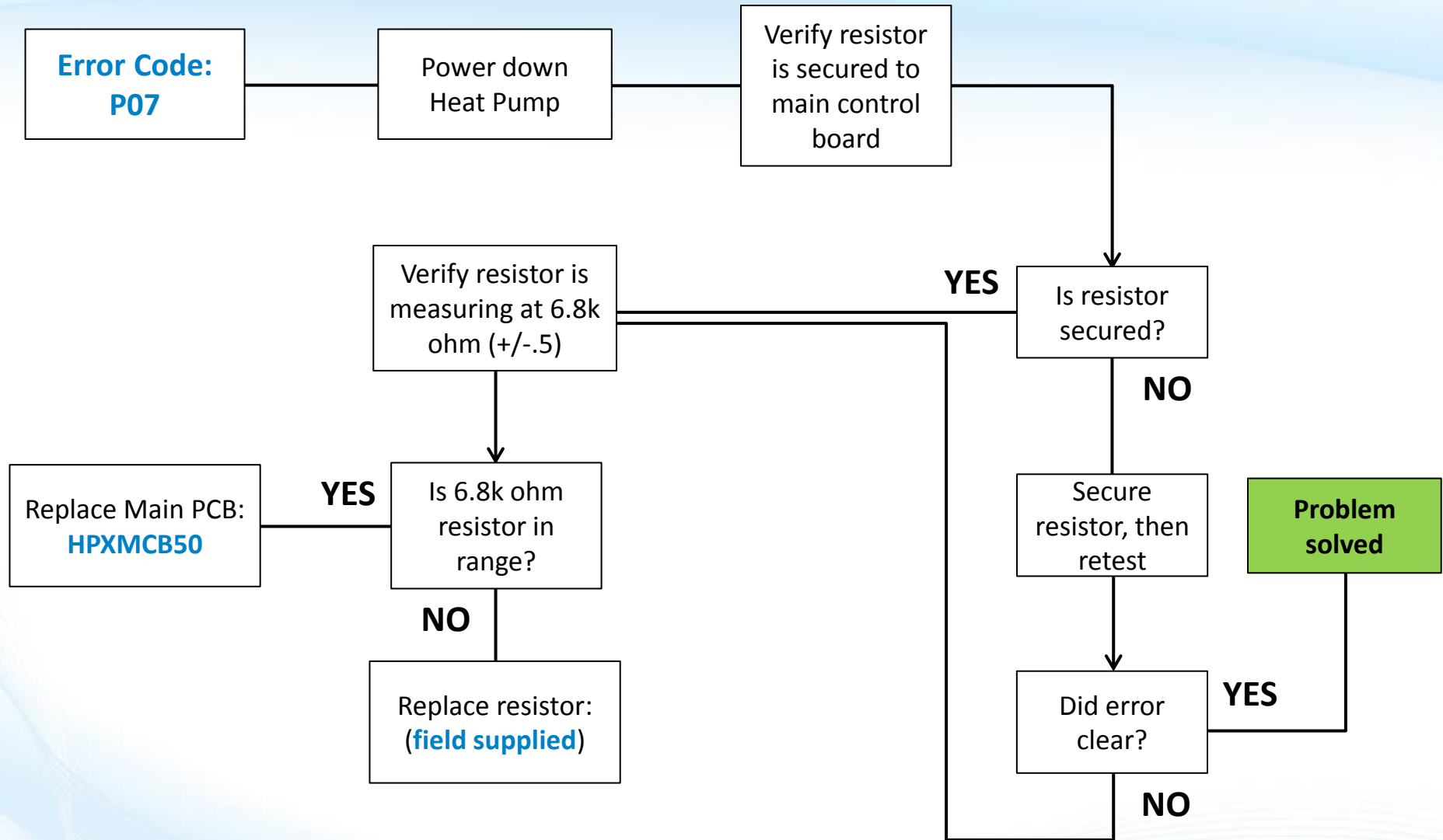

2. Error Code: P07

Locate and test the 6.8k Ohm resistor on the main control PCB. If the resistor is out of range, replace it, otherwise replace the main control PCB.

Power Down & Locate Resistor

Step 2A

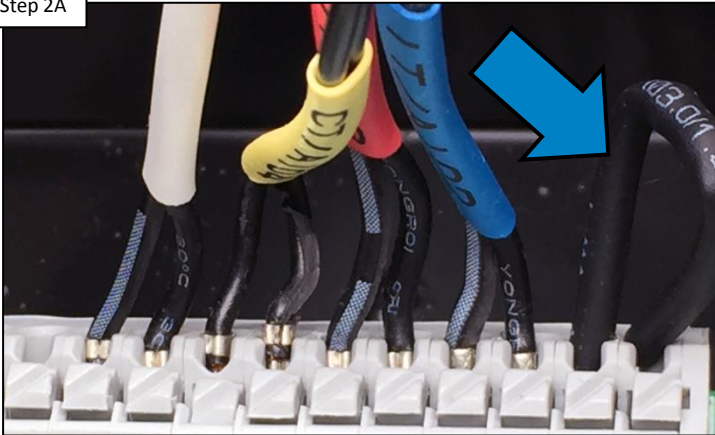

Power down the heat pump, and locate the resistor. Verify it is secured to the main control PCB. IF not, secure the resistor and retest. IF secured, proceed to step 2B.

Measure Resistance

Step 2B



Measure the resistor, verifying 6.8k ohms (+/- .5). IF the resistance is correct, replace the main control PCB (**HPXMCB50**). IF incorrect, replace the 6.8k ohm resistor (**Field Supplied**).

NOTE: 6.8k ohm resistor is not reading with +/- .5, then replace it with a locally sourced 6.8k ohm resistor.



3. Error Code: E01

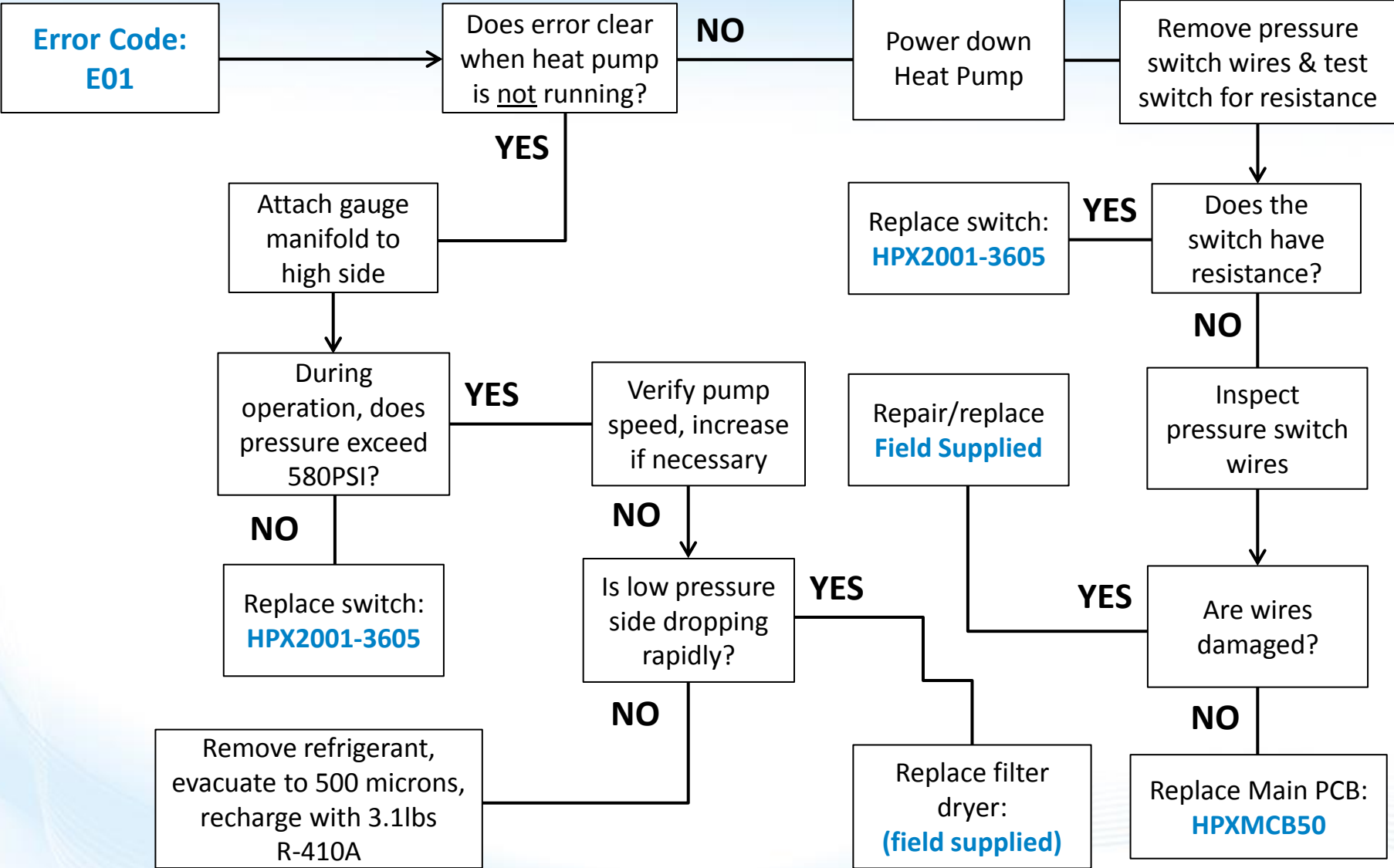

3. Error Code: E01

An Error Code: E01 relates to a problem detected on the high refrigerant pressure side. This could be caused by a problem with the pressure switch, pressure switch wiring, control board PCB, the water supply, the filter dryer, or the Heat Pumps refrigerant charge.

Does Error Clear?

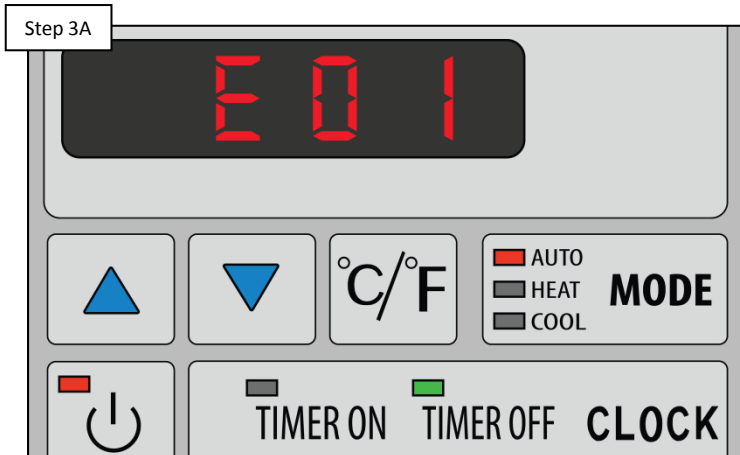

To isolate an E01 error, first verify whether the error clears when the heat pump is not running. IF the error clears, go to 3D. IF the error does not clear, jump to step 3B.

Power Down & Test Pressure Switch



Power down heat pump, disconnect high pressure switch wires & measure switch for resistance. IF resistance is identified, replace switch ([HPX2001-3605](#)). IF no resistance, go to step 3C.

3. Error Code: E01 (cont.)

If pressure switch wires are damaged then they will need to be repaired or replaced, as this will cause issues between the control board and the pressure switch.

Inspect Pressure Switch Wires

Step 3C



If pressure switch wires are damaged, this will affect how the control board interacts with the switch. IF wires are damaged, repair/replace (**Field Supplied**). IF not damaged, replace main control PCB (**HPXMCB50**).

Verify High Pressure Side

Step 3D



Attach high pressure manifold gauge. IF during operation the pressure exceeds 580PSI, go to step 3E. IF it does not exceed 580PSI, replace pressure switch (**HPX2001-3605**).

NOTE: A pressure gauge adaptor (1/4" male SAE to 5/16" female SAE) must be field supplied to test the high and low pressure manifolds.



3. Error Code: E01 (cont.)

Overcharging the Heat Pump can also cause an Error Code E01. If overcharged recover refrigerant from the heat pump, evacuate to 500 microns, and recharge with 3.1lbs R-410A refrigerant.

Pump Speed & Low Pressure Side

Step 3E



Verify flow through heater is minimum 20GPM, correct if necessary. Monitor the low pressure side. IF low pressure is falling rapidly, while high pressure increases, replace filter dryer (field supplied). IF not, go to step 3F.

Recharge Heat Pump

Step 3F

Recharge Specifications

Evacuate to 500 microns

Recharge with 3.1lbs of R-410A

If the heat pump is overcharged this can cause an E01 error code. Power heat pump down and remove refrigerant. Evacuate system to 500 microns. Then recharge with 3.1lbs of R-410A. IF this does not correct the problem, contact support (908) 355-7995.

4. Error Code: E02

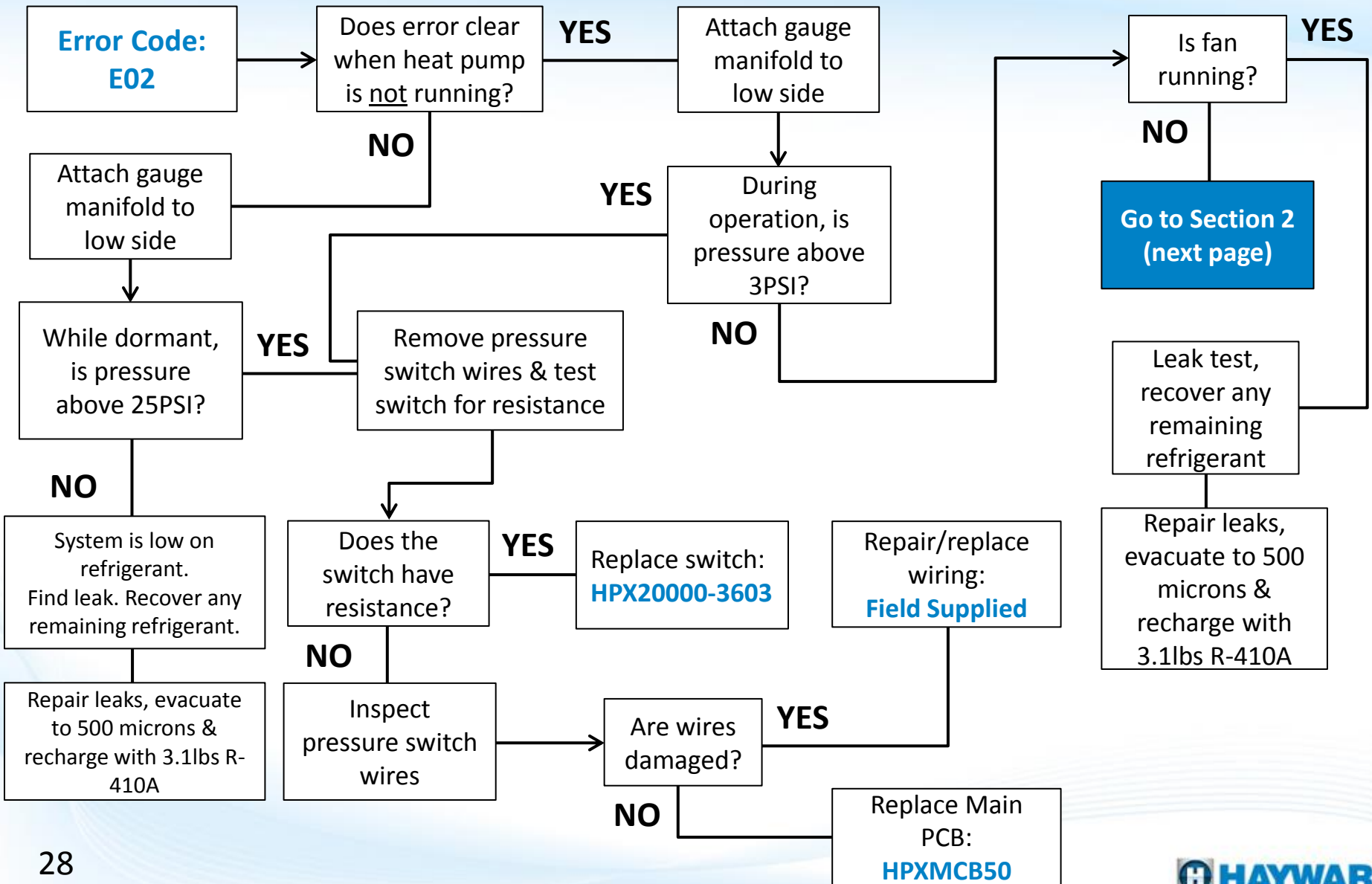

4. Error Code: E02

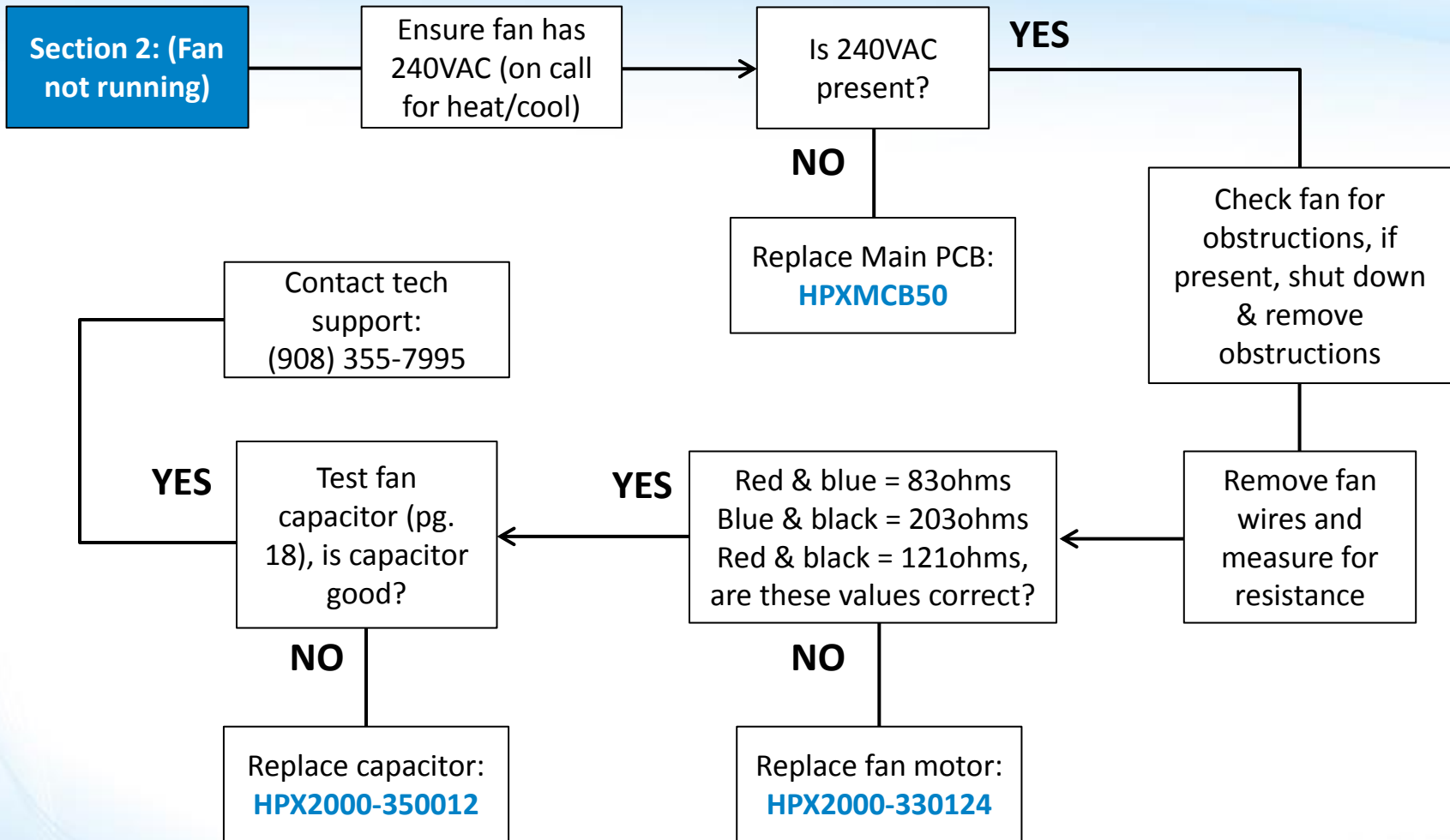

4. Error Code: E02

While the heat pump is in its dormant (not running) state, the low side pressure should read at least 25PSI.

Does Error Clear?

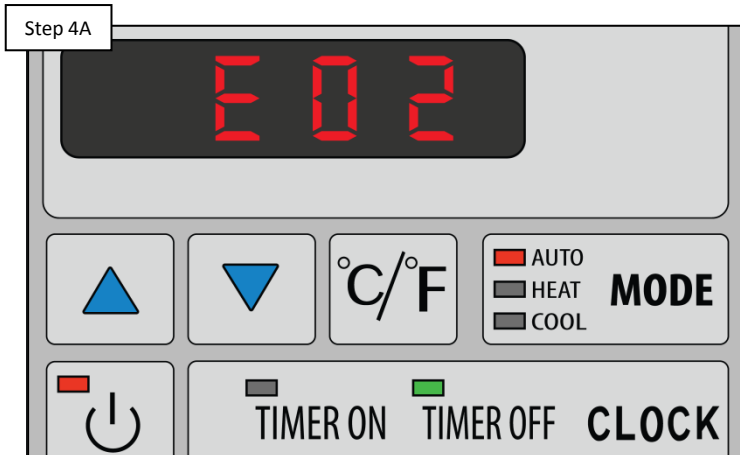

To isolate an E02 error, first verify whether the error clears when the heat pump is not running. IF the error does not clear, go to 4B. IF error clears, jump ahead to step 4F.

Verify Low Pressure Side



Attach low pressure manifold gauge. With the heat pump OFF, verify the pressure is above 25PSI. IF the pressure is below 25PSI, go to 4C. IF above 25PSI, jump ahead to step 4D.

NOTE: A pressure gauge adaptor (1/4" male SAE to 5/16" female SAE) must be field supplied to test the high and low pressure manifolds.



4. Error Code: E02 (cont.)

If the heat pump does not have 25PSI of pressure on the low pressure side, while dormant (not running), then it likely has a leak.

Leak Test & Recharge Heat Pump

Step 4C

Recharge Specifications

Evacuate to 500 microns

Recharge with 3.1lbs of R-410A

Test the heat pump for leaks & repair as needed. Power heat pump down and recover any remaining refrigerant. Repair leak. Evacuate to 500 microns. Then recharge with 3.1lbs of R-410A. IF this does not correct the problem, contact support (908) 355-7995.

Power Down & Test Pressure Switch

Step 4D



Power down heat pump, disconnect low pressure switch wires & measure switch for resistance. IF resistance is identified, replace switch (HPX2001-3605). IF no resistance, proceed to step 4E, to inspect pressure switch wires.

4. Error Code: E02 (cont.)

While the heat pump is running, the low side pressure should read at least 3PSI.

Inspect Pressure Switch Wires

Step 4E



If pressure switch wires are damaged, this will affect how the control board interacts with the switch. IF wires are damaged, repair/replace (field supplied). IF not damaged, replace main control PCB (HPXMCB50).

Verify Low Pressure Side

Step 4F

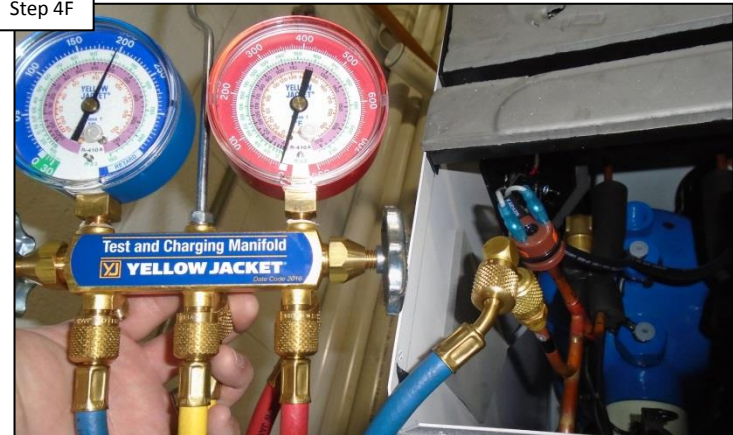

Attach low pressure manifold gauge. With the heat running, verify the pressure is at least 3PSI. IF pressure is below 3PSI, go to 4G. IF equal to or above 3PSI, go back to step 4D.

4. Error Code: E02 (cont.)

If the fan is not running when the heat pump is calling for heat/cool, this could affect the low side pressure. Verify whether the fan is running when calling for heat/cool.

During Operation Inspect Fan

Step 4G

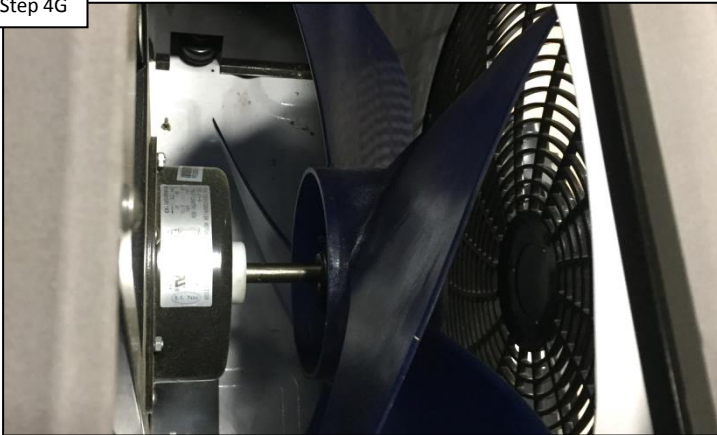

If the fan is not running, this will affect the low side pressure. Verify whether the fan is running. IF the fan is running go to step 4H. IF not running, jump ahead to step 4I.

Leak Test & Recharge Heat Pump

Step 4H

Recharge Specifications

Evacuate to 500 microns

Recharge with 3.1lbs of R-410A

Test the heat pump for leaks & repair as needed. Power heat pump down and recover remaining refrigerant. Repair leak. Evacuate to 500 microns. Then recharge with 3.1lbs of R-410A. IF this does not correct the problem, contact support (908) 355-7995.

4. Error Code: E02 (cont.)

Obstructions to the fan may include: nests, sticks, broken fan guard, or other debris that may be preventing the fan blade from spinning.

Verify Fan Input Power

Step 4I

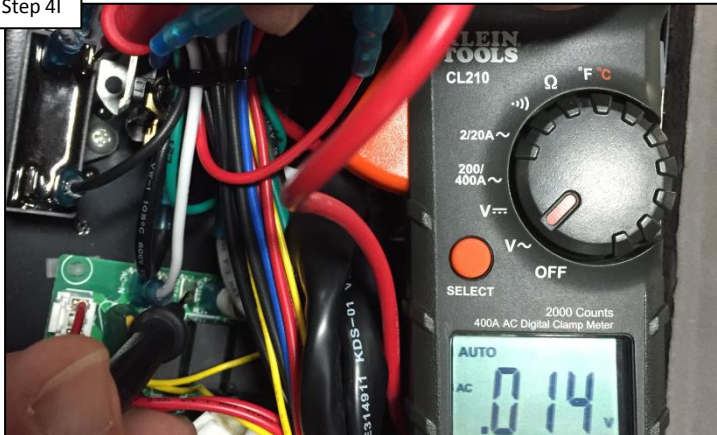

During operation the fan should have 240VAC input power. Measure for 240VAC off terminals (blue wire on fan capacitor and red wire at output 4) on the fan. IF no/low voltage, replace the main control PCB ([HPXMCB50](#)). IF correct, go to 4J.

Verify Fan is Free of Obstructions

Step 4J

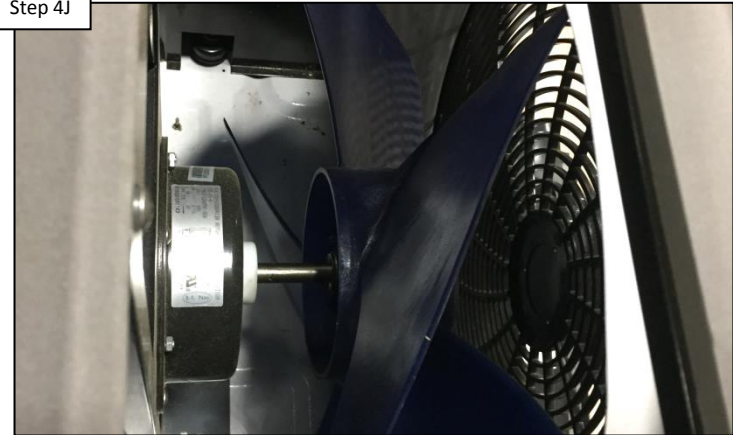

Turn off power & make sure the fan can move freely. IF the fan is being obstructed by something, remove the obstruction and retest. IF the fan is free of obstructions and is able to move freely, then proceed to step 4K, to test the fan wires.

4. Error Code: E02 (cont.)

To test the fan motor, isolate the motor wires and measure resistance across red & blue (83ohms), blue & black (203ohms), and red & black (121ohms).

Disconnect & Test Fan Motor

Step 4K

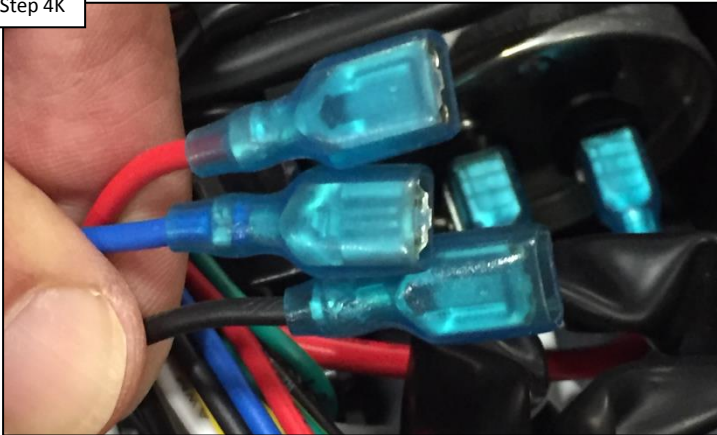

Isolate the fan and measure resistance across the wires. They should be: between red & blue (83ohms), blue & black (203ohms), & red & black (121ohms). IF correct go to 4L. IF incorrect, replace the fan motor ([HPX2000-330124](#)).

Test Fan Capacitor

Step 4L



Disconnect wires to the fan capacitor and measure for resistance ([pg. 18](#)). IF capacitor tests bad, then replace the fan capacitor ([HPX2000-350012](#)). IF correct contact tech support for further assistance (908) 355-7995.

5. Error Code: E03

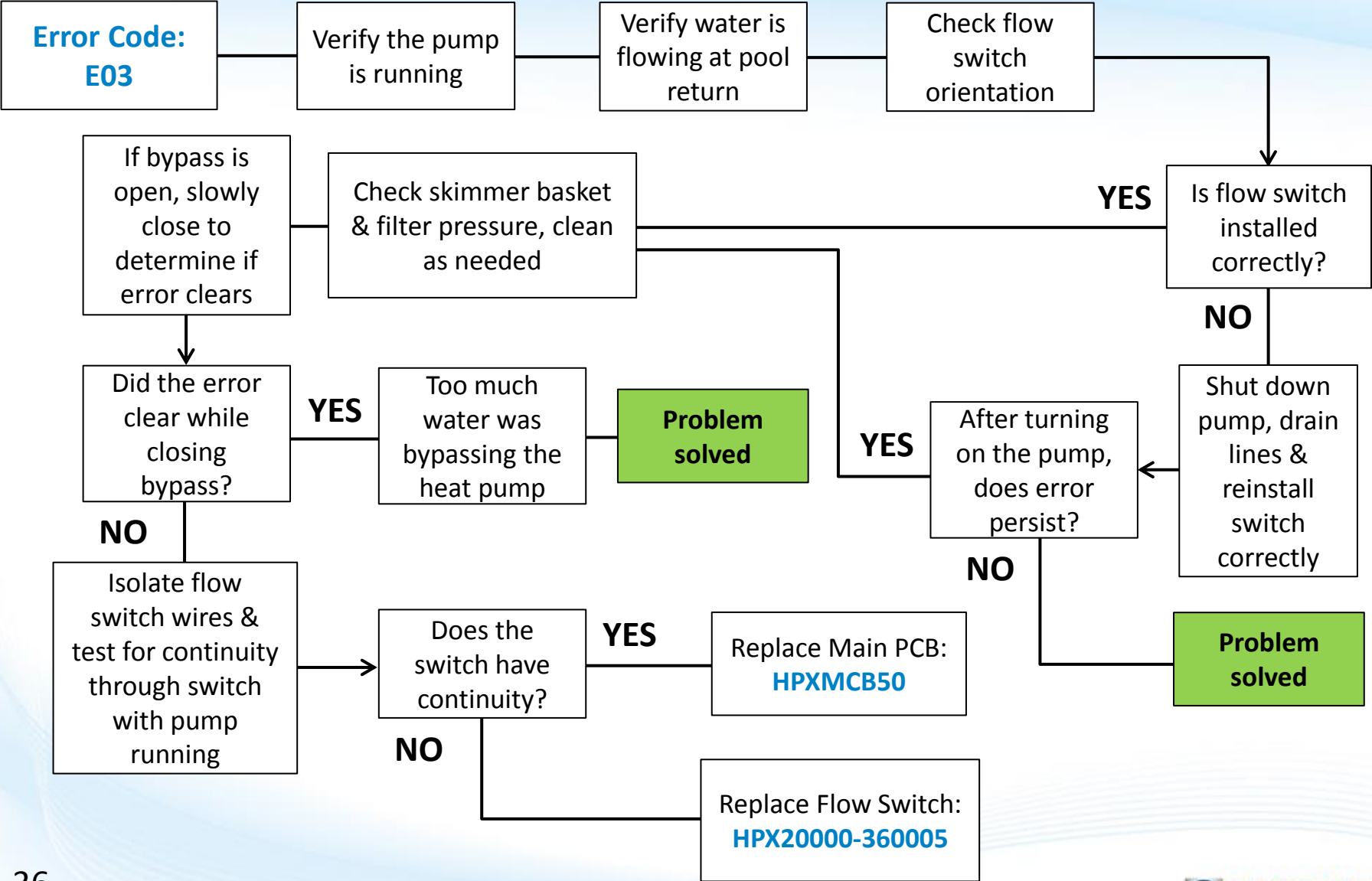

5. Error Code: E03

Error Code 03 is reporting a flow error. Verify the pump is not only on and running but circulating water through the heat pump before proceeding.

Verify Flow

Step 5A



Verify the pump is on and water is passing through the heat pump. Finally, check the pool return to make sure water is circulating in the pool. IF correct, go to step 5B. IF incorrect, resolve & retest.

Verify Flow Switch Orientation

Step 5B



Verify the flow switch is mounted in the correct orientation. IF the flow switch is installed properly, go to 5C. Otherwise, turn off pump, correct orientation, and retest.

5. Error Code: E03 (cont.)

Check the skimmer, pump basket, filter pressure. Clean as needed. If the error clears after cleaning the filter, note the current pump speed and filter for future reference.

Check Skimmer & Filter Pressure

Step 5C

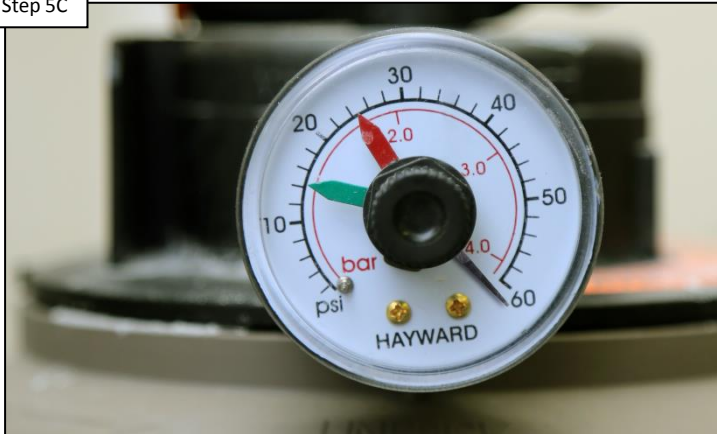

Inspect the skimmer, filter pressure, & pump basket. Clean as needed. IF after cleaning the error persists continue to step 5D. If the error clears, make note of the filter pressure and pump speed.

Slowly Close Bypass

Step 5D



If the bypass is open, slowly close the bypass, checking to see if this clears the E03. The bypass may be causing the flow error. IF the error clears, fully close or leave the bypass in its current position. IF not, go to 5E.

5. Error Code: E03 (cont.)

When the flow requirements of the heat pump are satisfied, the flow switch should register continuity, and it should report as open at insufficient flow.

Isolate Flow Switch & Test



Isolate the flow switch (disconnecting the wires from the control board). With the pump running, test for continuity through the switch. IF no continuity, replace the switch ([HPX20000-360005](#)). IF continuity is present, replace the main control board ([HPXMCB50](#))

6. Error Code: E06

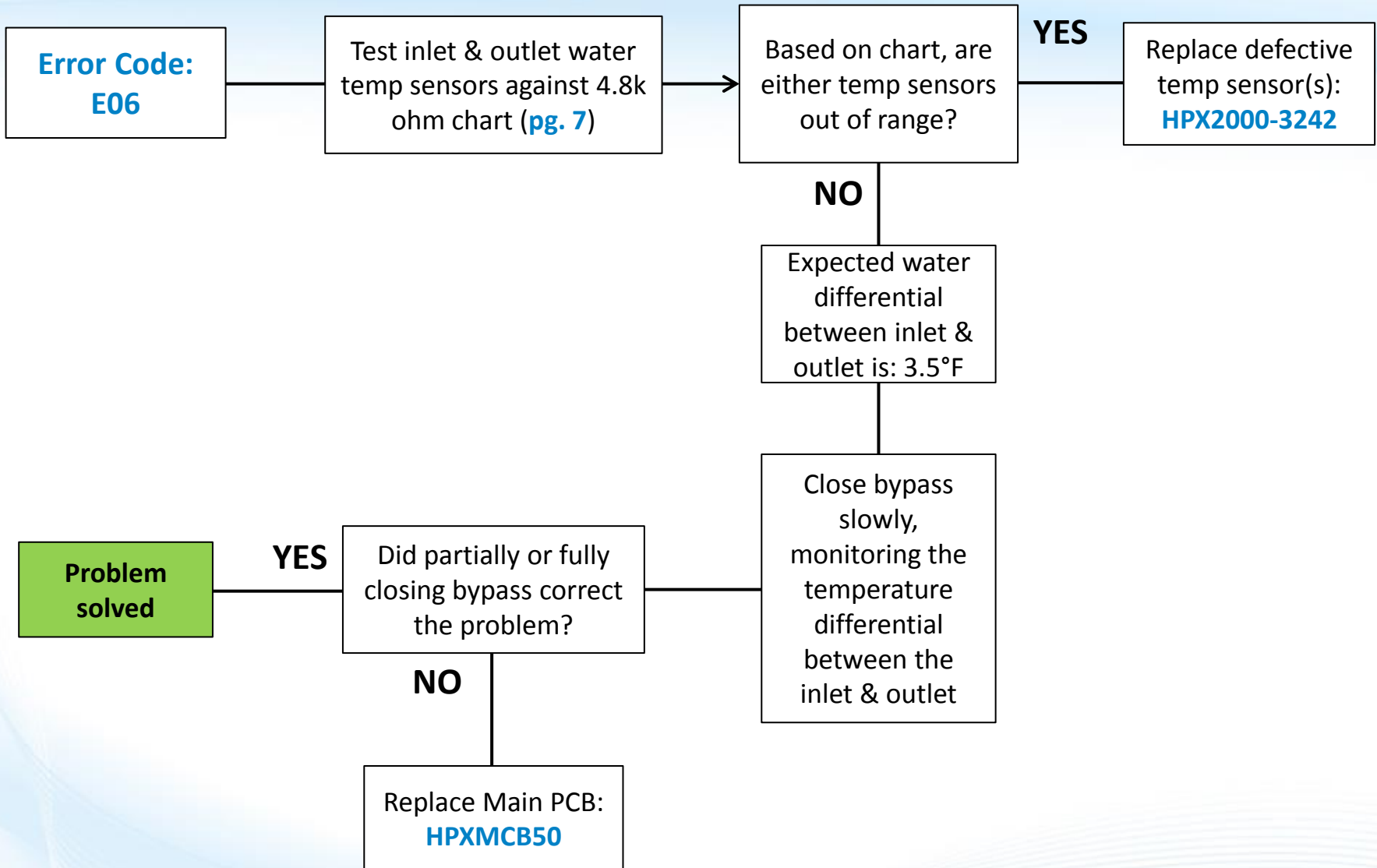

6. Error Code: E06

The E06 error implies that the temperature differential between the inlet and outlet water sensors is greater than 58°F; however the expected differential between these sensors should be closer to 3.5°F.

Test Inlet & Outlet Temp Sensors

Step 6A

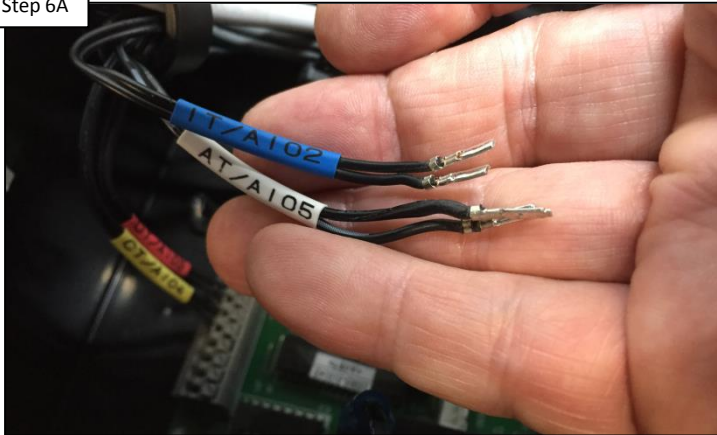

Following the chart (pg. 7), verify whether the inlet & outlet water temperature sensors are reading accurately. IF they are, go to step 6B. IF not, replace defective sensor(s) (HPX2000-3242).

Monitor Differential (closing bypass)

Step 6B



The expected differential, between the inlet and outlet is 3.5°F. Slowly close the bypass, monitoring the differential. IF closing the bypass does not correct the problem, replace the main PCB (HPXMCB50).

7. Error Code: E07/E19/E29

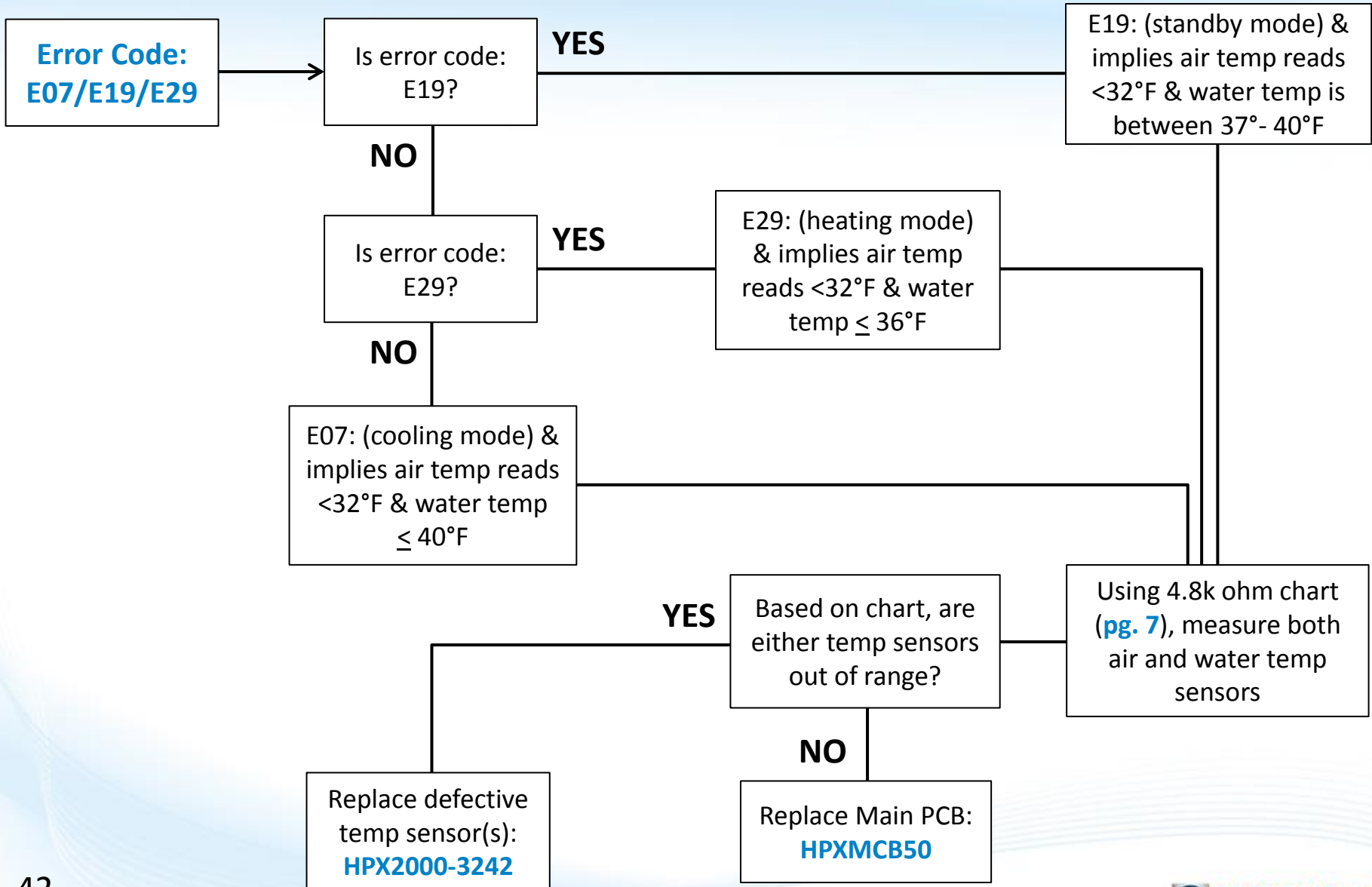



7. Error Code: E07/E19/E29

Error Codes: E07, E19, & E29 all refer to different versions of freeze protection and are based on reported temperature reading by the ambient air temp sensor and inlet water temp sensor.

Which Error Code

Step 7A

	Step 7B
	Step 7C
	Step 7D

IF the error code is an E07, go to step 7B. IF the error code is an E19, jump to step 7C. IF the error code is reporting as a E29, then jump ahead to step 7D.

Error Code: E07

Step 7B

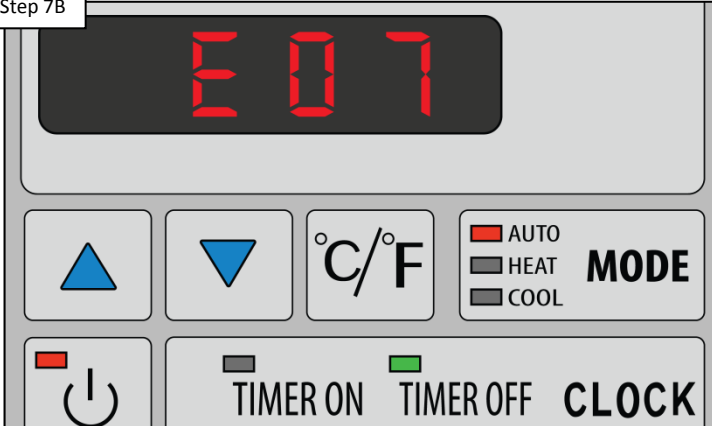

The control panel features a digital display at the top showing 'E07'. Below the display are several control buttons and indicators: a blue up arrow, a blue down arrow, a temperature unit selector (C/F), a mode selector (AUTO, HEAT, COOL), a power button, and a timer selector (TIMER ON, TIMER OFF). The word 'MODE' is positioned to the right of the mode selector, and 'CLOCK' is positioned to the right of the timer selector.

An E07 Error Code will appear in cooling mode & implies air temp reads <32°F & water temp < 40°F. Jump to step 7E to verify sensors.

7. Error Code: E07/E19/E29 (cont.)

Error Codes: E07, E19, & E29 all refer to different versions of freeze protection and are based on reported temperature reading by the ambient air temp sensor and inlet water temp sensor.

Error Code: E19

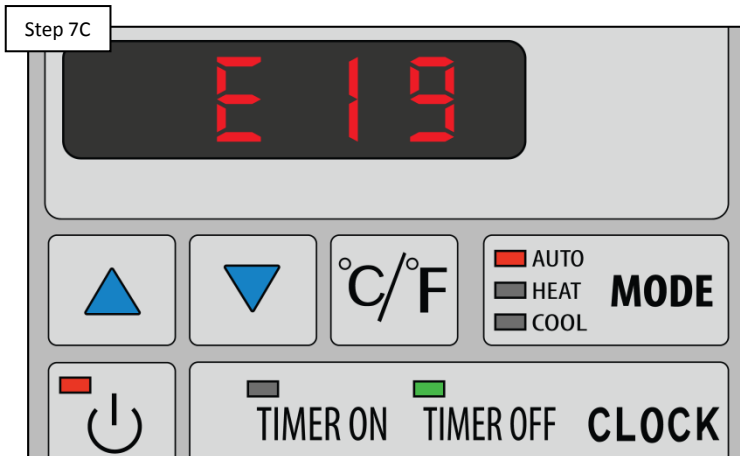

An E19 Error Code will appear in standby mode & implies air temp reads <32°F & water temp is between 37°- 40°F. Jump to step 7E to verify sensors.

Error Code: E29

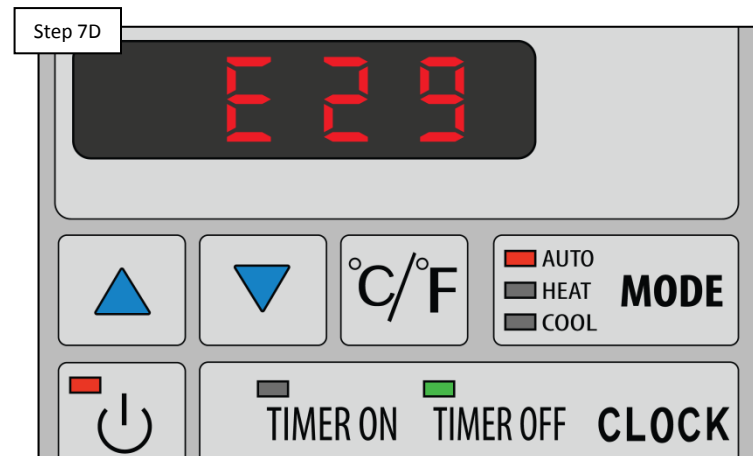

An E29 Error Code will appear in heating mode & implies air temp reads <32°F & water temp < 36°F. Jump to step 7E to verify sensors.

7. Error Code: E07/E19/E29 (cont.)

Either the sensor(s) is/are causing the problem or the problem resides in the main control board.

Test the Air & Inlet Temp Sensors

Step 7E

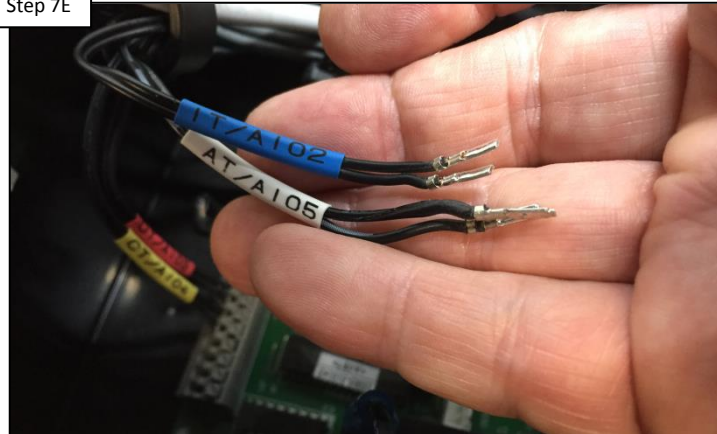

Following the chart (pg. 7), verify whether the air & inlet water temperature sensors are reading accurately. IF they are not, replace defective sensor(s) (HPX2000-3242). IF they are, replace main PCB (HPXMCB50).

8. Error Code: E08

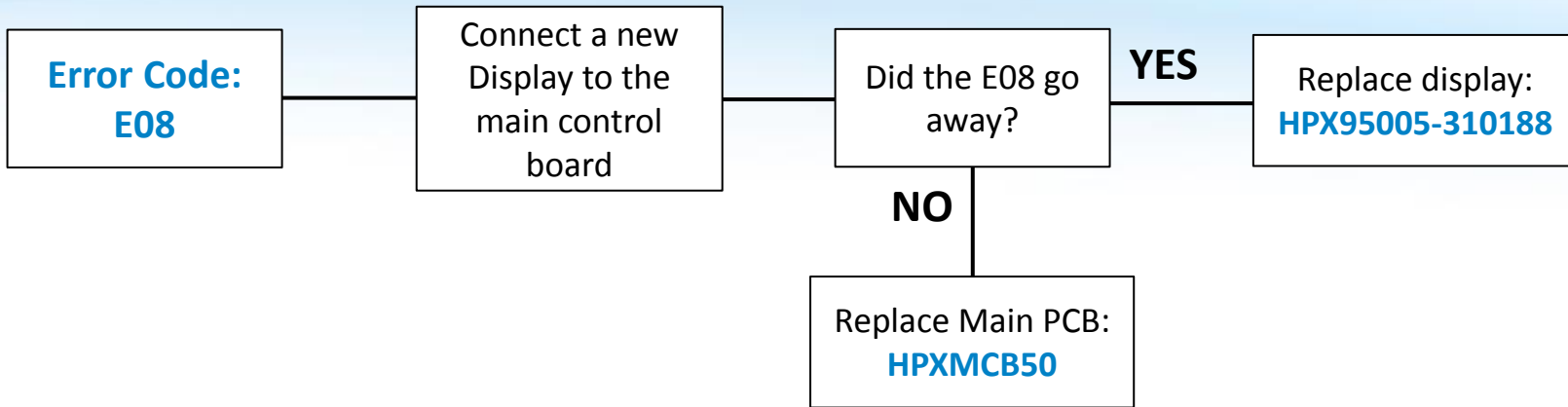

8. Error Code: E08

An Error Code: E08 refers to a communication error between the display (user interface) and the main control board.

Replace Display

Step 8A

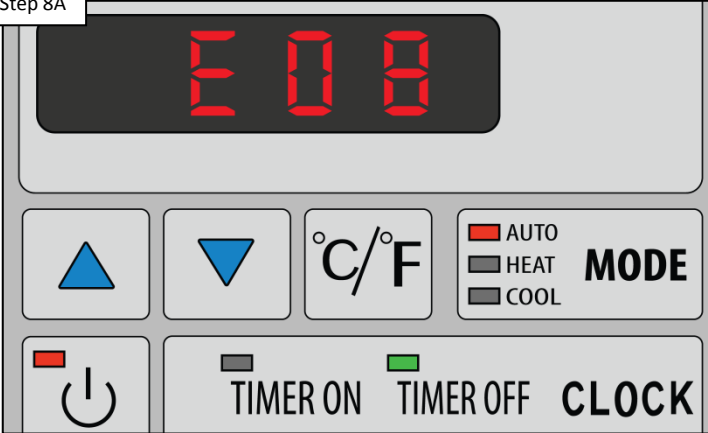

Swap display (user interface) with a new display board ([HPX95005-310188](#)). IF the problem goes away, keep the new display board on. IF the problem persists, replace the main control board ([HPXMCB50](#)).

Reading Serial Numbers

Beginning 2005

21121607 000717035



21121607

= Common to all ID tags.

21121607

= Plant of manufacture:

100 = Canada

110 = Pomona, CA

120 = Clemmons, NC

130 = Nashville, TN

21121607

= Year & Month of manufacture:

402 = 2004, Feb

405 = 2004, May

501 = 2005, Jan

607 = 2006, July

000717035

= Manufacturing ID